

DETTAGLIO
SCALA 1 : 10

DETTAGLIO
SCALA 1 : 2

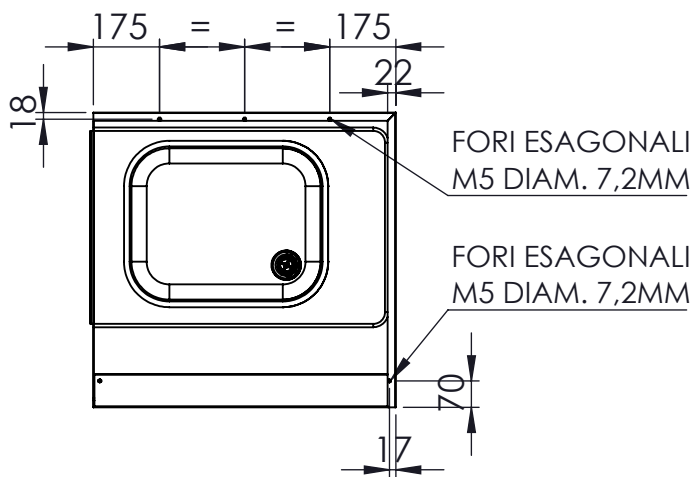
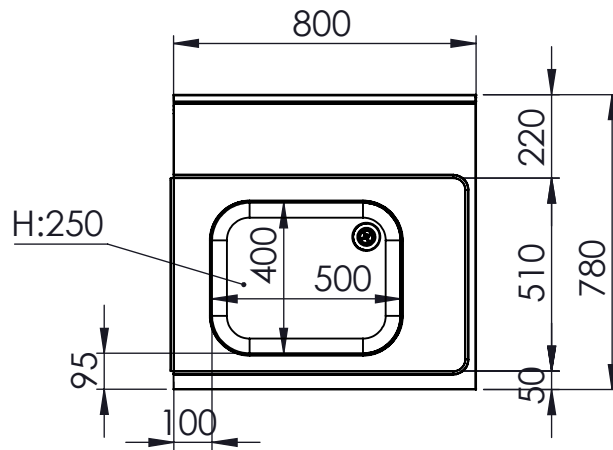

DISEGNATO	
DATA	18/01/2024
PESO	10914.36

CODICE: **MQ00**



CONFIGURAZIONE: **L:800 P:780**

SCALA: 1:20

A4

FOGLIO 1 DI 1